

14-016

Originele naam: Buscema I

Eurocircuits referentie: E671846

Bijzonderheden:

E671846

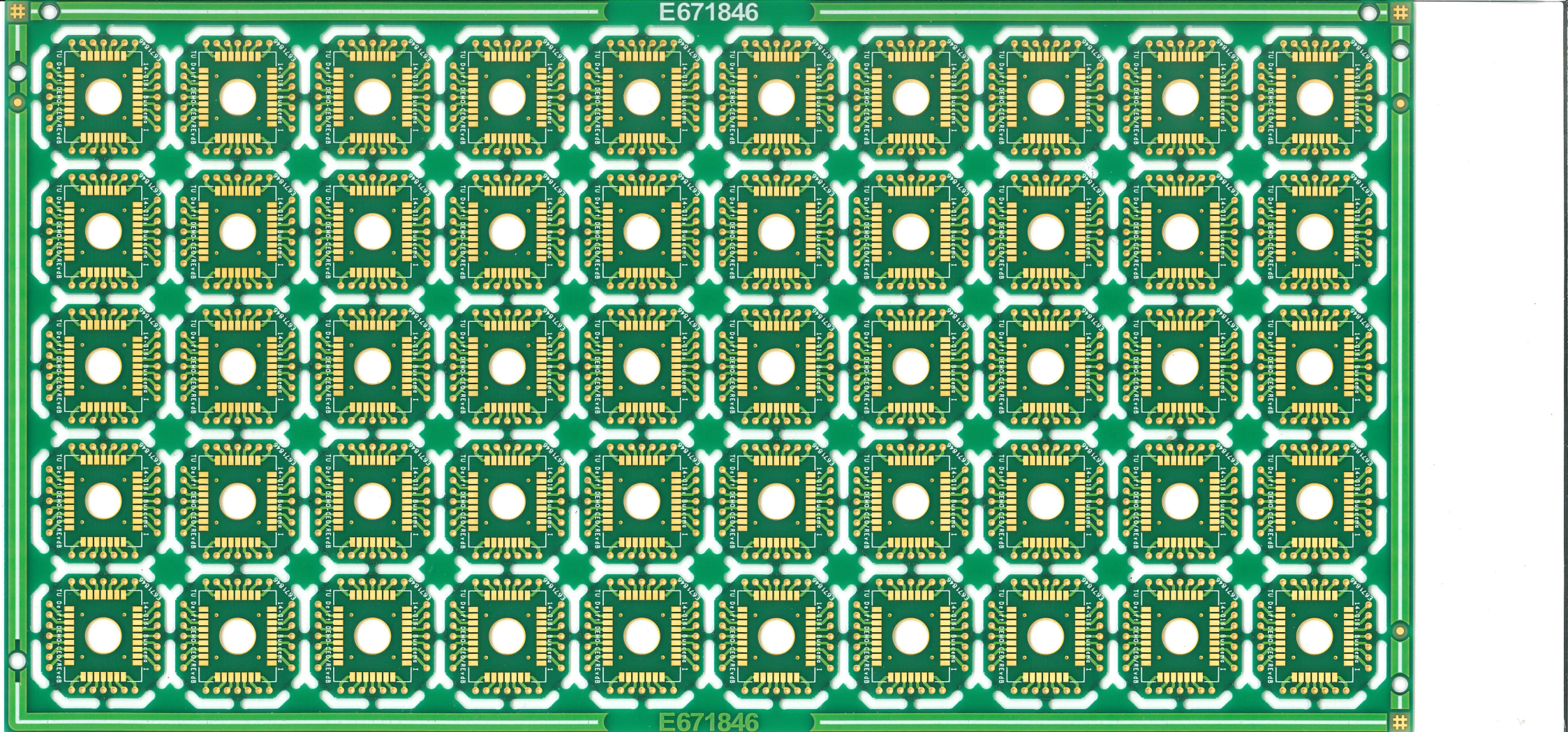

E671846

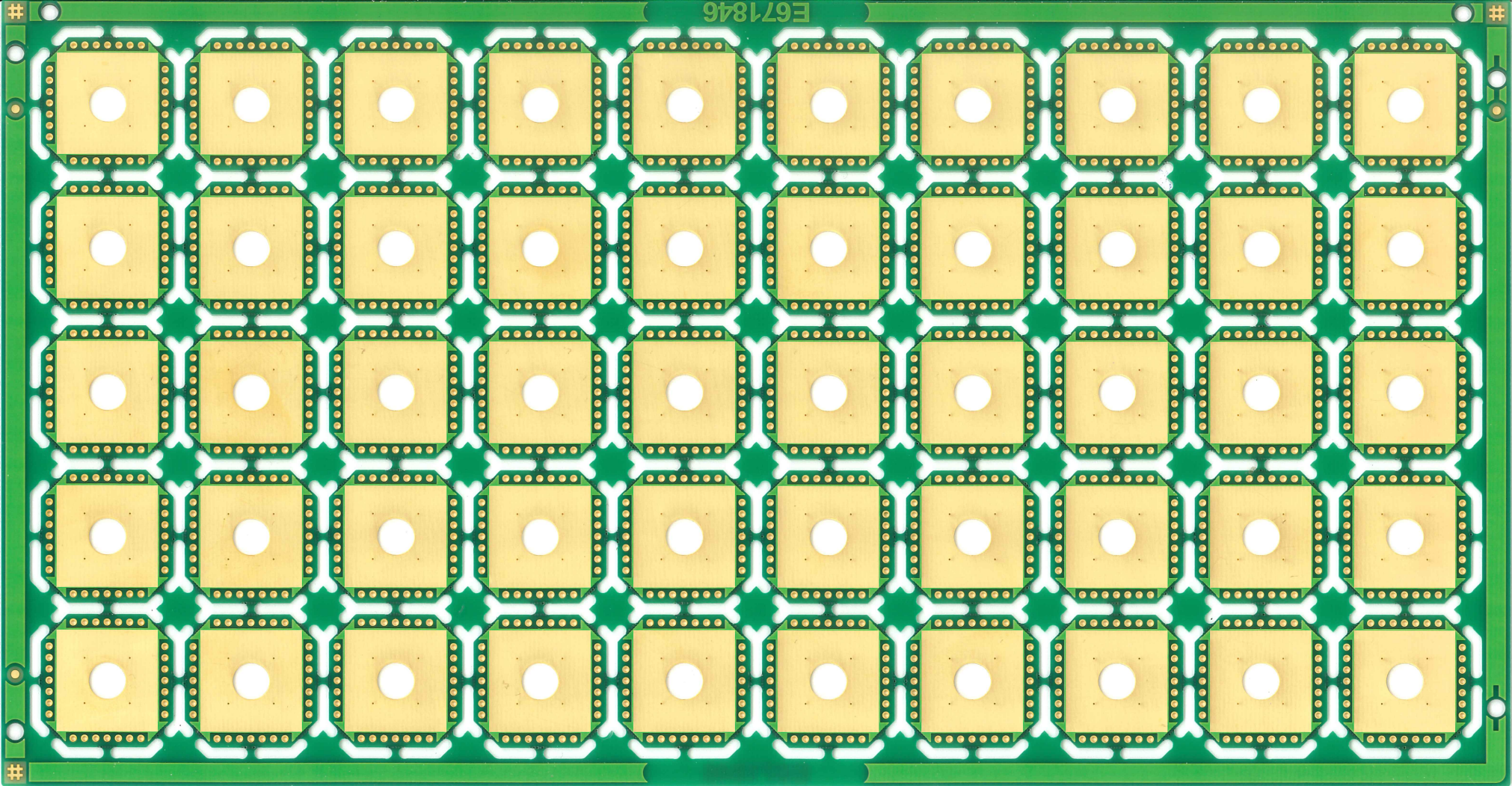

E671846

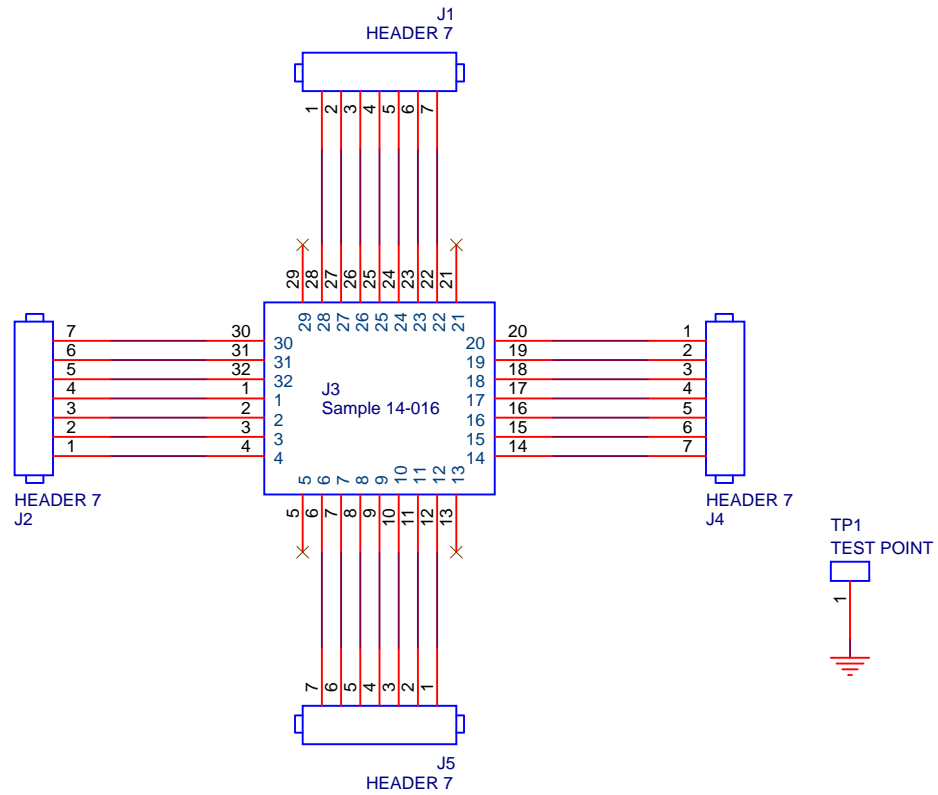

DEMO-CEO
 Van der Waalsweg 8
 2628 CH Delft

Title
 Buscema I

Size A4	Document Number 14-016	Rev 1
------------	---------------------------	----------

Date: Wednesday, October 29, 2014 Sheet 1 of 1

E671846 PCB view TOP (topview)

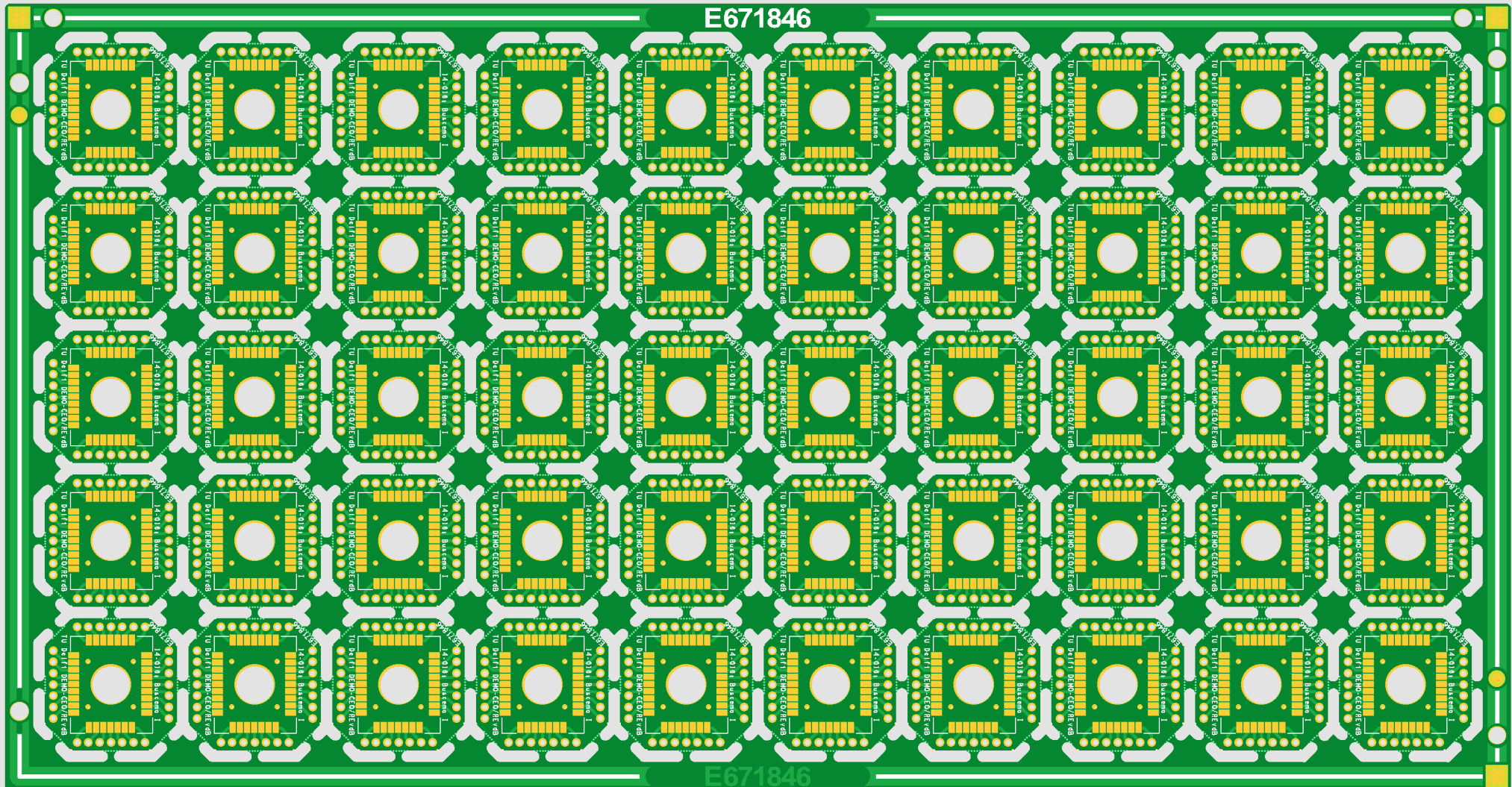

E671846

E671846

E671846 TOP layer Image (topview)

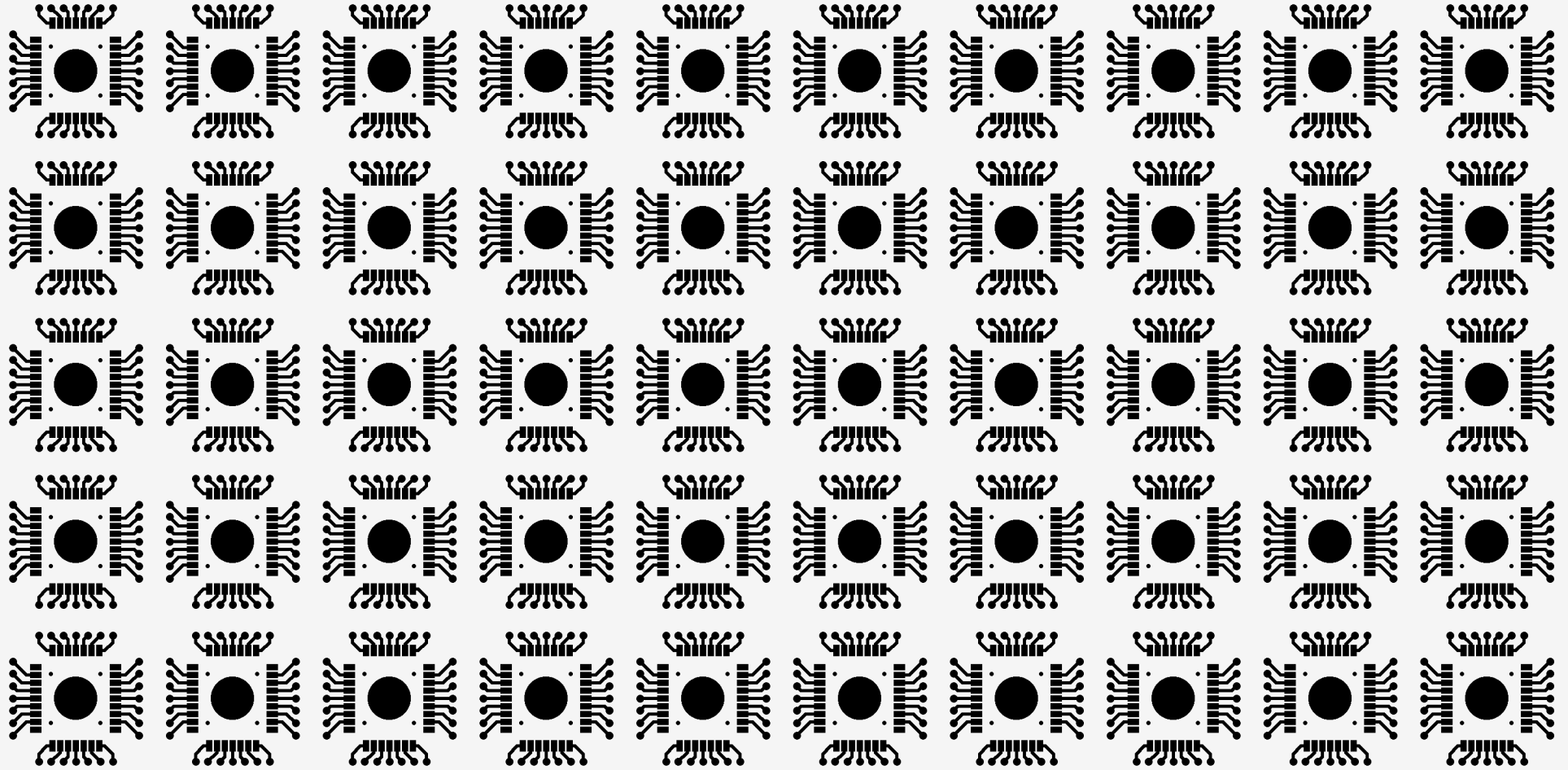

E671846

E671846 BOTTOM layer Image (topview)

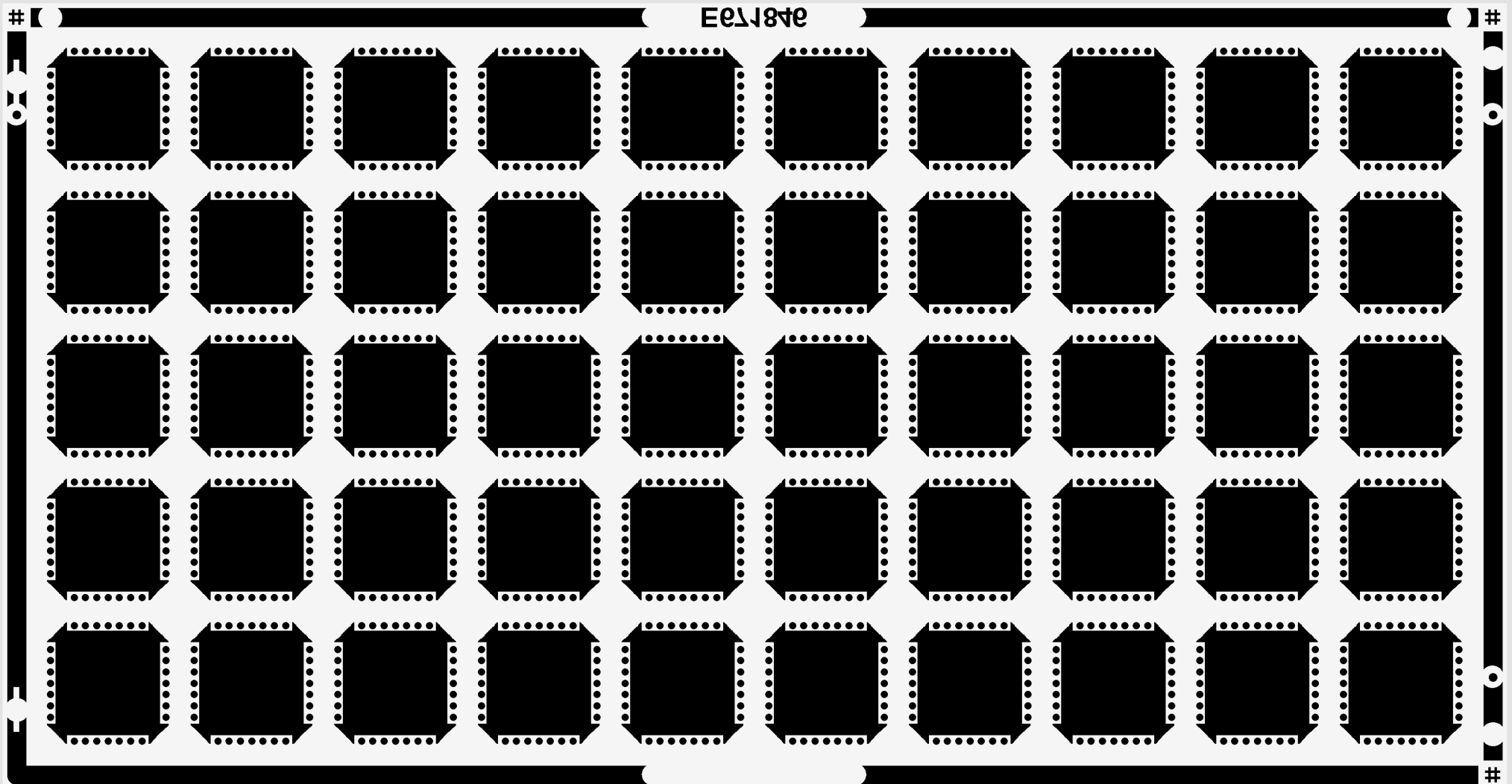

E671846 PCB view BOTTOM (bottomview)

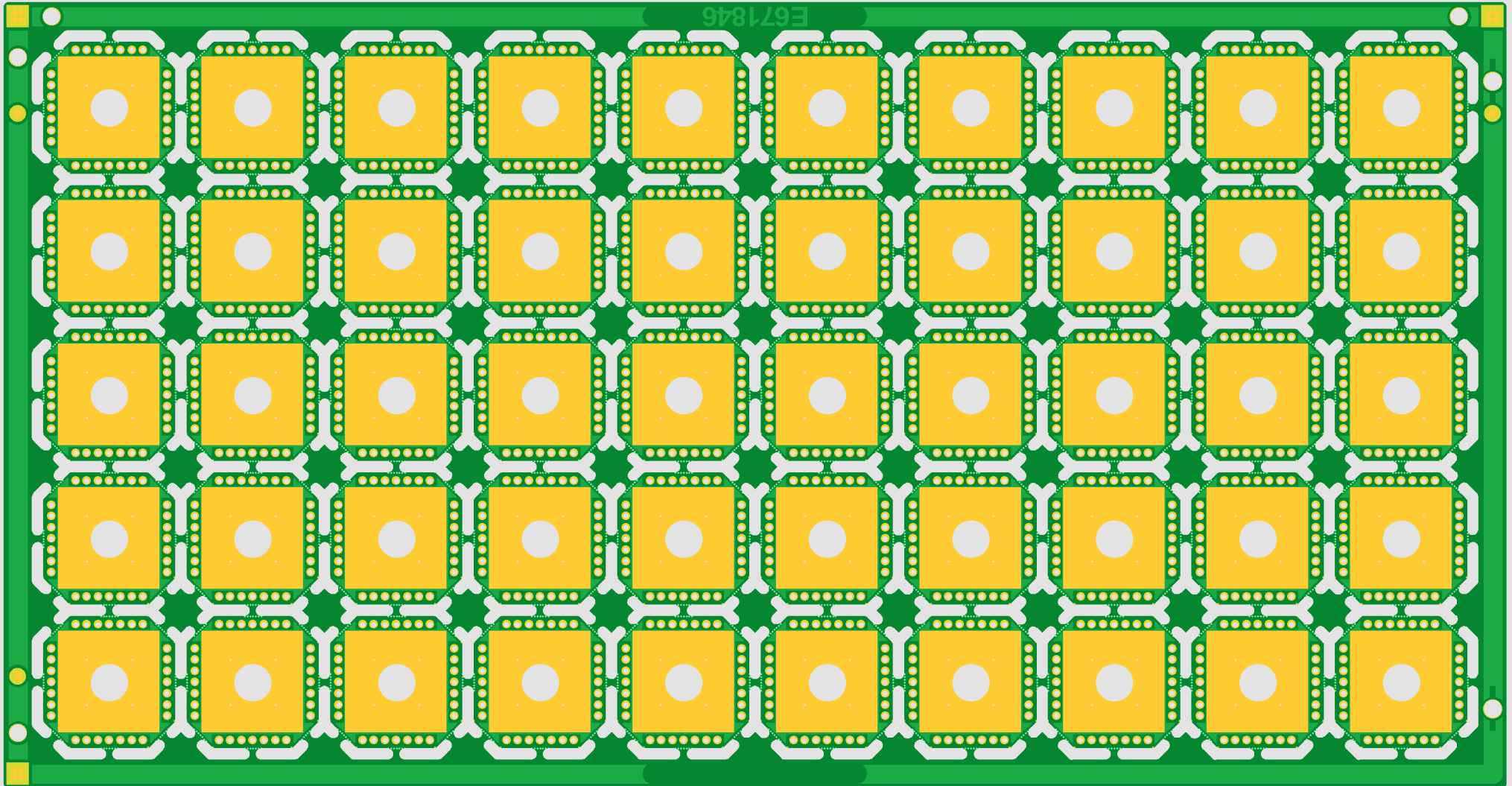

E671846 PCB Mechanical view (topview)

139.50

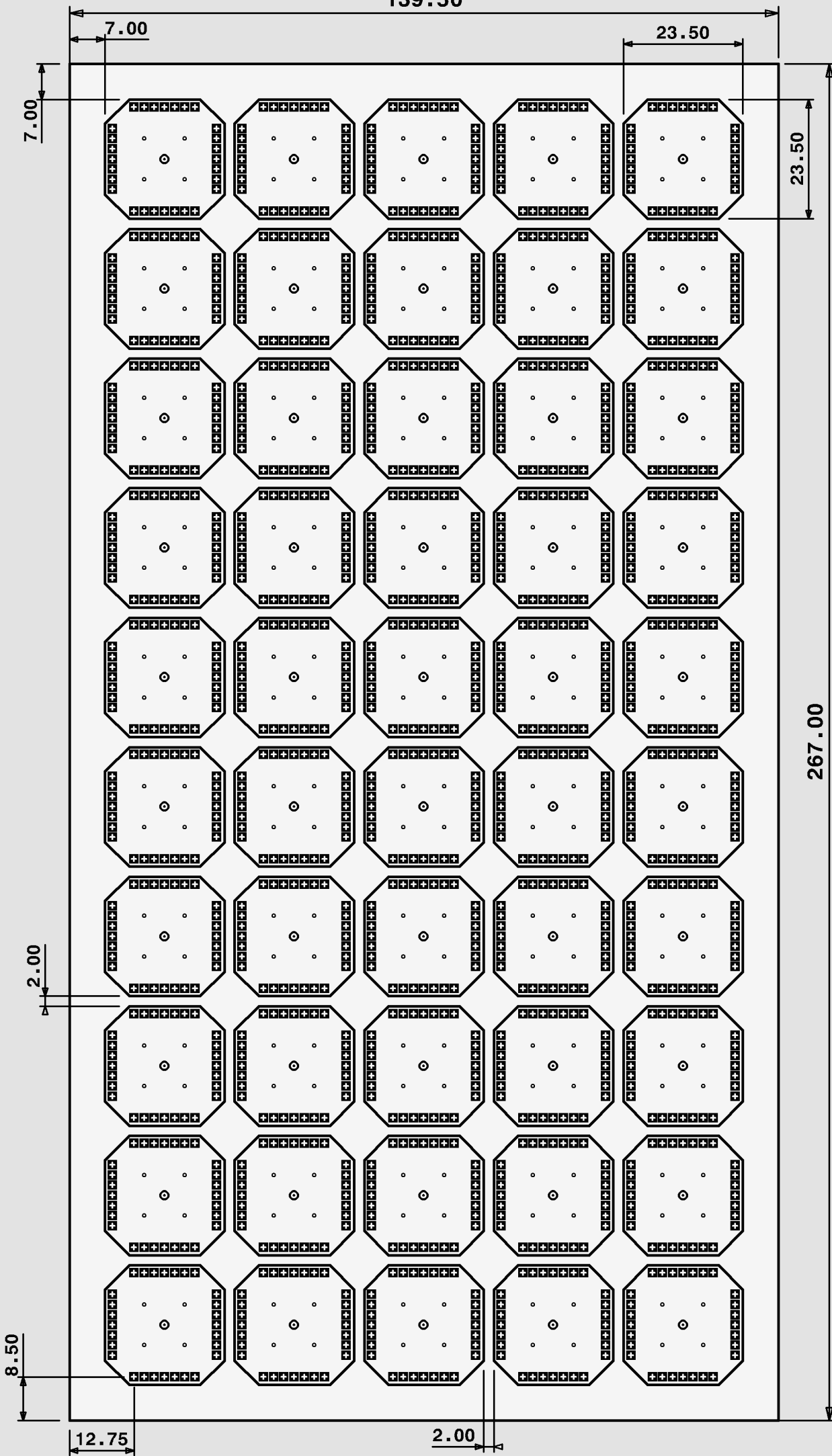

Drill Report : Layer E671846-60

Symbol	END.dia (mm)	Tooldia (*0.01mm)	number of Holes	spec.desc. Nibb(N) mill(M)	NPTH
•	0.25	35	200	0	
⊕	0.80	90	1400	0	
⊙	6.50	660	50	0	